

Instruction Manual

Pneumatic Diaphragm Valve MV 302

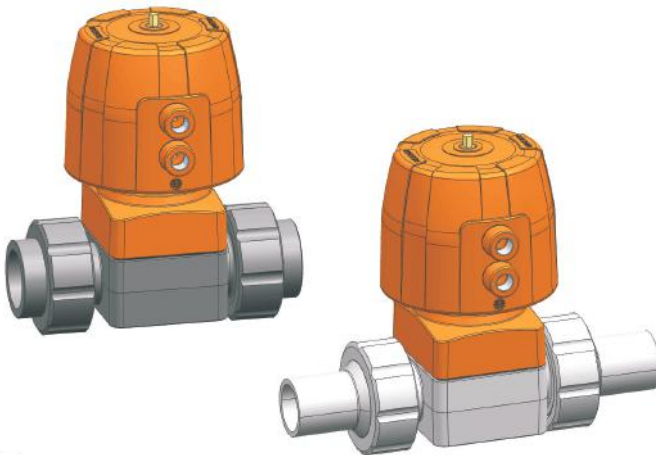

Content

1	Regarding this document	02
2	Intended use	03
3	Safety and responsibility	04
4	Transport and storage	04
5	Design and function	05
6	Technical Data	07
7	Installation	12
8	Initial operation	14
9	Maintenance	15
10	Troubleshooting list	17
11	List of spare parts	18
12	Disposal	19

Original instruction manual

Observe instruction manual



The instruction manual is part of the product and an important element within the safety concept.

- ▶ Read and observe instruction manual.
- ▶ Always have instruction manual available at the product.
- ▶ Pass on instruction manual to all subsequent users of the product.



1 Regarding this document

1.1 Warning notices

This instruction manual contains warning notices that shall prevent you from death, injuries or material damages. Always read and observe these warning notices!

Warning symbol	Meaning
 DANGER	Imminent danger! Failure to observe these warnings could result in death or very serious injuries. Measurements to avoid the danger.
 WARNING	Possible imminent danger! Failure to observe these warnings could result in very serious injuries. Measurements to avoid the danger.
 CAUTION	Dangerous situation! Failure to observe these warnings could result in small injuries. Measurements to avoid the danger.
CAUTION	Dangerous situation! Failure to observe these warnings could result in material damages. Measurements to avoid the danger.

1.2 Further symbols and labels

	Notes: Especially important information for comprehension included.
	Call for action: Here, you have to do something.
	Call for action in a certain order: Here, you have to do something.

1.3 Related documents

KOSCN industry

These documents can be obtained from www.koscn.de

2 Intended use

The following descriptions apply to the pneumatic Diaphragm Valve Type 302 with control mode NC, NO and DA.

The Diaphragm Valve Type 302 intended exclusively for shutting- off and conveying media in the allowable pressure and temperature range or for controlling a flow in piping systems into which they have been installed.

The following Control Functions are available:

- Single acting pneumatic actuator with spring for Fail safe to close operation
- Single acting pneumatic actuator with spring for Fail safe to open operation
- Double acting pneumatic actuator DA

2.1 Abbreviations

NC	NC-mode / Fail-safe-to-close
NO	NO-mode / Fail-safe-to-open
DA	DA-mode / Double acting

3 Safety and responsibility

The valve is intended to be used in order to chapter 1 "Intended use".

- ▶ Only operate the diaphragm Valve in faultless and correct conditions.
- ▶ Check the safety devices on the compressed air supply side of the system regularly to ensure they are functioning correctly. Do not use the product if damaged or faulty. Sort out the product immediately if damaged.
- ▶ The product and accessories are installed only by persons who have the required training, knowledge or experience.
- ▶ Make sure that the piping system is correctly laid and that it is regularly inspected.
- ▶ Ensure that the pneumatic actuator control is operated only by sufficiently qualified and authorized personnel.
- ▶ Train the Personnel regularly on all matters related to the local regulations on occupational health and safety and environmental protection, especially regarding pressurized pipes and electrical devices in case.
- ▶ Respect the operating instructions for the valve and all other additional modules.

4 Transport and storage

The product has to be treated, transported and stocked carefully.

Follow the instructions below:

- ▶ Protect the product against external force during transport (impact, stroke, vibrations).
- ▶ Transport and/or store product in its original packaging.
- ▶ Make sure that the product cannot be damaged neither by mechanical nor by chemical impacts.
- ▶ Check the product prior to assembly on transport damages.
- ▶ Protect the product from dust, dirt, moisture as well as heat and ultraviolet radiation.
- ▶ Especially the connections have to be protected against mechanical and chemical impacts.

5 Design and function

5.1 Design

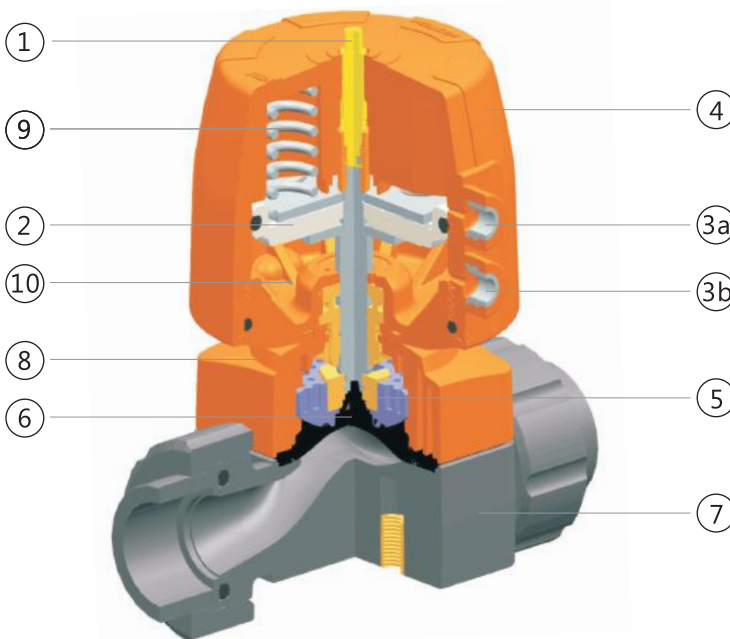

Legend

Pos.	Name	Pos.	Name
1	Position Indicator	5	Compressor
2	Piston	6	Diaphragm
3a	Air connection for NO control mode	7	Valve body
3b	Air connection for NC control mode	8	The cover
3a+3b	Air connections for DA control mode	9	Spring set for NC mode
4	Housing with plastic- plastic Connection	10	Spring housing for NO mode

 The valve configuration of the DA control mode is not using a spring (Pos. 9 or Pos. 10)

NOTICE

For types with function NC or NO, the control air connection which is not used contains the vent hole. Keep the connection which is not used open and protect it from pollution.

5.2 Function

5.2.1 NC-mode / Fail-safe-to-close

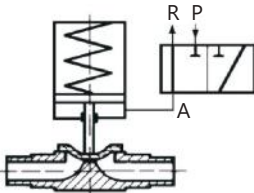

- ▶ 3/2 way solenoid valves are used to control single acting actuators (NC).
- ▶ They are mounted either directly to the actuator via a banjo bolt or via a battery mounting plate or valve cluster, as required.

5.2.3 NO-mode / Fail-safe-to-open

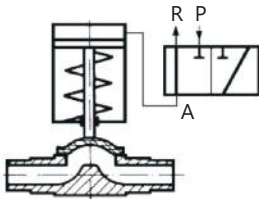

- ▶ 3/2-way solenoid valves are used to control single acting actuators (NO).
- ▶ They are mounted either directly to the actuator via a banjo bolt or via a battery mounting plate or valve cluster, as required.

5.2.3 DA-mode / Double acting

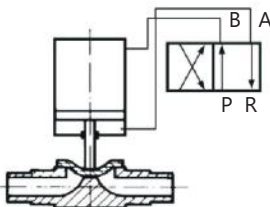

- ▶ 4/2 way solenoid valves are used to control double acting actuators (DA).
- ▶ They are mounted either directly to the actuator via a Namur connector plate or via valve clusters.

5.3 Diaphragm Valve Type plate

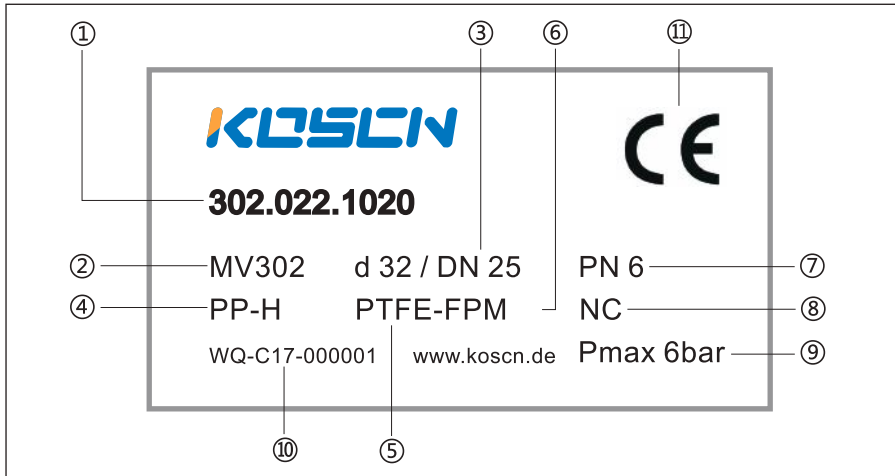

Pos.	Name	Pos.	Name
1	Code number	6	O-ring material
2	Type	7	Pressure Rating
3	Dimension	8	Control mode
4	Valve body material	9	Max. Pressure
5	Diaphragm material	10	Serial number
		11	CE-Marking

6 Technical Data

6.1 Connection of control media

	NC	NO	DA
DN15-50		G1/4	



Damage to the diaphragm valve by faulty installation!
 The air duct has to be mounted tension- free without any bends or knots!

6.2 Control Medium

NC-mode	NO-mode	DA-mode
Max. 6 bar	Max. 5 bar	
ISO 8573-1 Compressed air class 2 or 3 at 10 °C		
ISO 8573-1 Compressed air class 3 or 4 at T > 0 °C		
Temperature of control medium max. 40°C		
Depending on the working Pressure PN. Lower control pressure may be selected		

6.3 Control volume

[dm³]

		d20	d25	d32	d40	d50	d63
		DN15	DN20	DN25	DN32	DN40	DN50
NC		0,12	0,12	0,12	0,24	0,24	0,24
NO		0,20	0,20	0,20	0,44	0,44	0,44
DA	Close	0,20	0,20	0,20	0,44	0,44	0,44
	Open	0,12	0,12	0,12	0,24	0,24	0,24

6.4 Pressure ranges

MV 302	NC	NO	DA
Material valve body*	PVC-U, PVC-C, PP-H, PP-Natural, PVDF		
Pressure rate [Bar]	EPDM, FPM, PTFE		
d20 DN15	6	6	6
d25 DN20	6	6	6
d32 DN25	6	6	6
d40 DN32	6	6	6
d50 DN40	6	6	6
d63 DN50	6	6	6

* Information of temperature resistance www.koscn.de

6.5 Control Pressure diagrams

MV302 NC with EPDM & FPM diaphragm

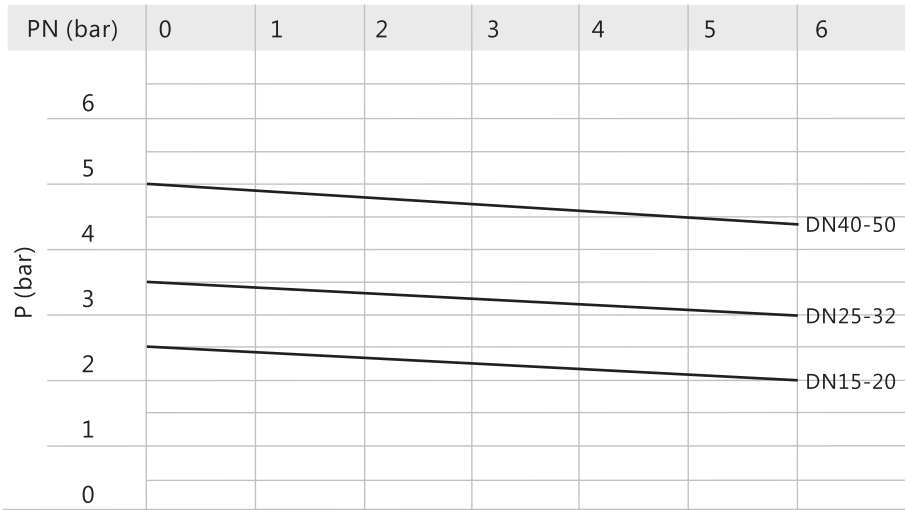

MV302 NC with PTFE diaphragm

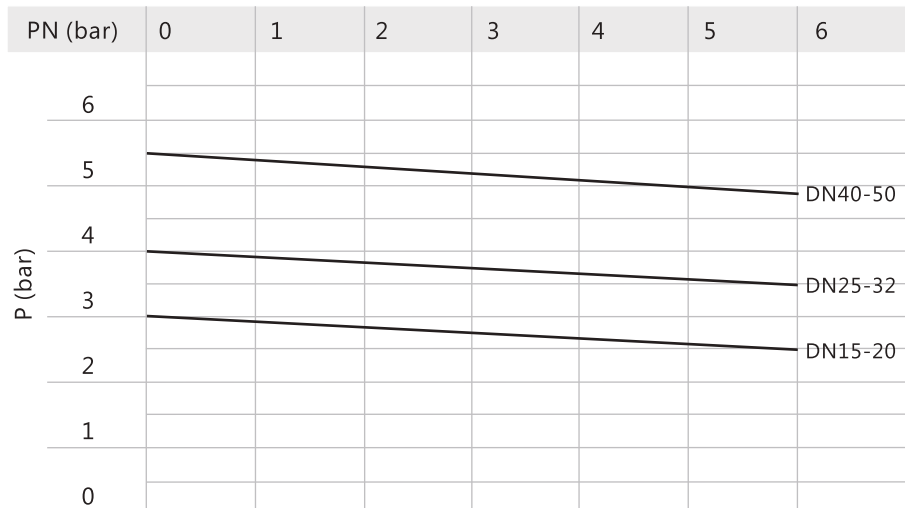

MV302 NO with EPDM & FPM diaphragm

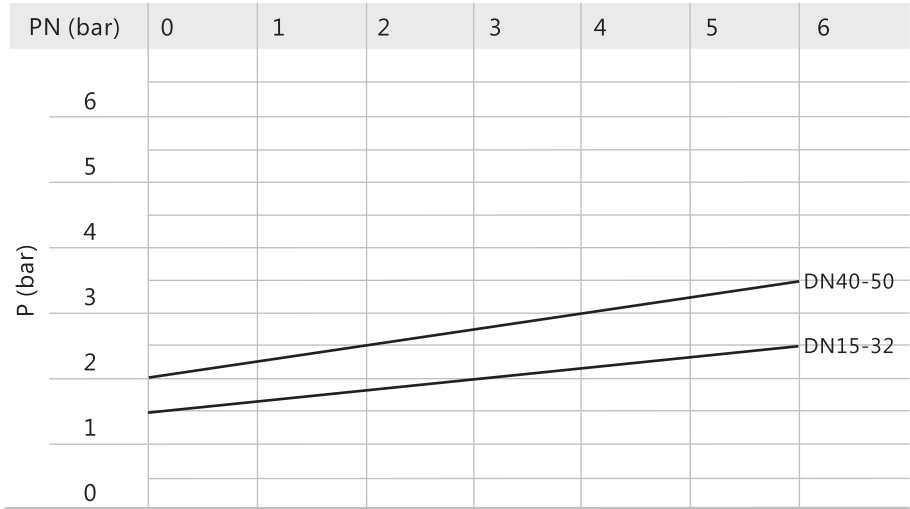

MV302 NO with PTFE diaphragm

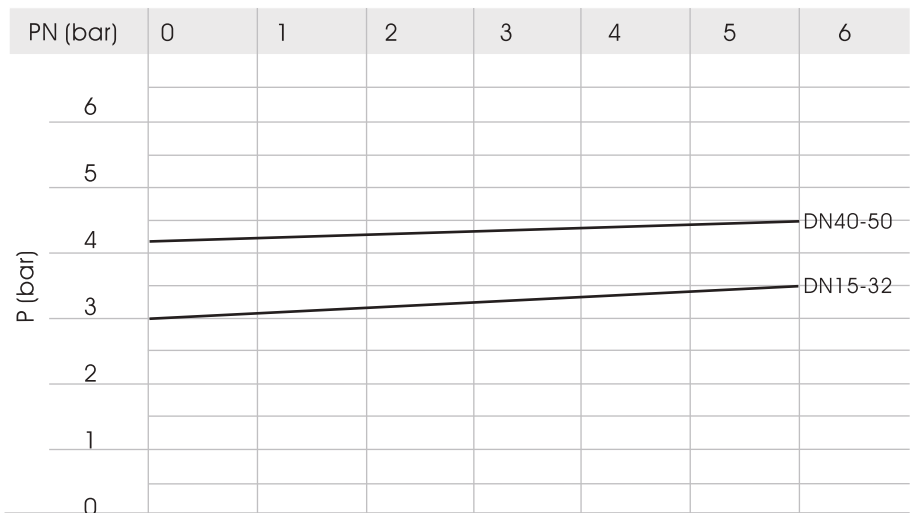

MV302 DA with EPDM & FPM diaphragm

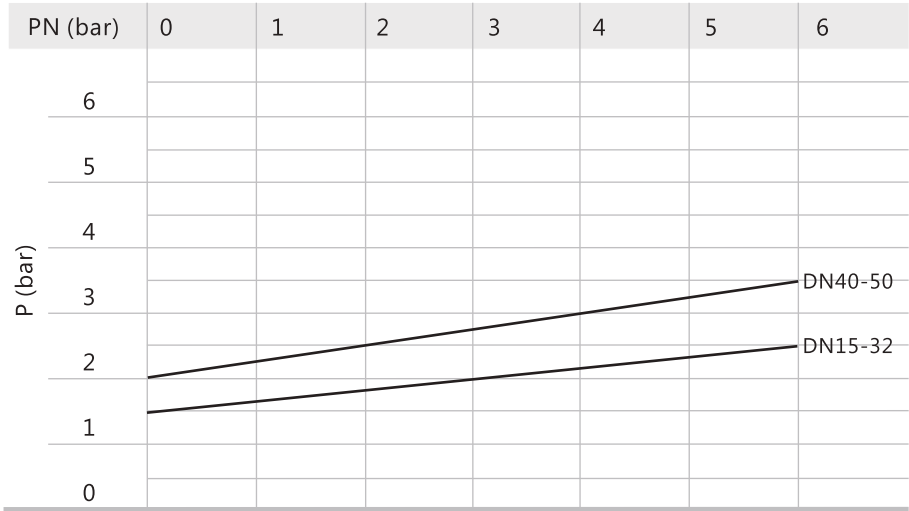

MV302 DA with PTFE diaphragm

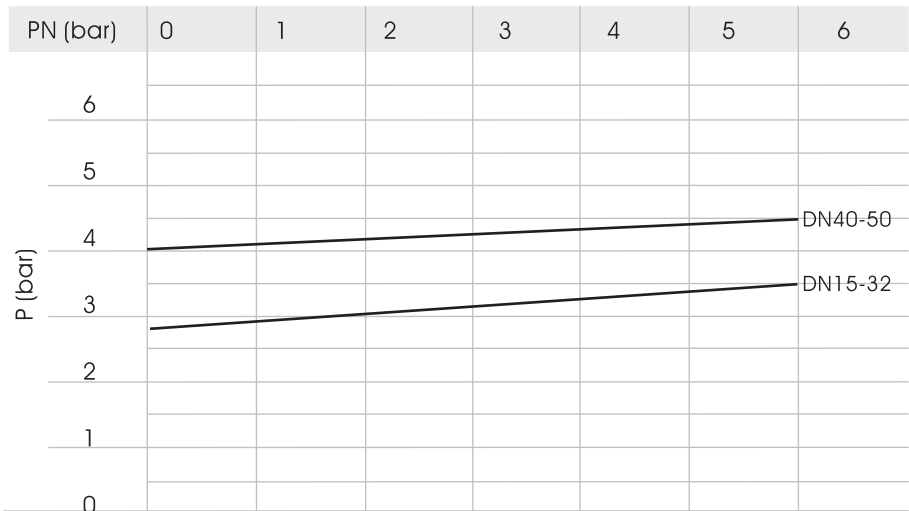

7 Installation

7.1 Preparation



Death or seriously injury could occur due to contact with the medium.

The use of grease, especially on amorphous plastics, can cause stress cracking on the valve body which can lead to leakages.

- ▶ Inspect the Diaphragm valve for transport damages. Damaged valves must not be installed.
- ▶ Only use diaphragm valve where the valve and the diaphragm correspond specifically to the materials, pressure rating, type of connection and dimensions for the particular application.
- ▶ Carry out function test: open and close the diaphragm valve. You must not install valves which do not function properly.
- ▶ Diaphragms and other sealing elements should be checked before mounting to make sure that there are no damages from aging. Aged parts which exhibit hardening or fissures must not be installed.

7.2 Installation



Failure to comply leads to a risk of personal injury!

Temperature changes can lead to longitudinal or lateral forces in the piping system with the risk of damages of the Diaphragm Valve. Make sure that the Diaphragm Valve is mounted in one of the following ways:

- Mount the diaphragm valve as a fixed point with the designated fastener or reinforce the piping directly before and after the diaphragm valve with suitable supports.
 - Diaphragm valves and piping must be aligned.
-
- ▶ Loosen the union nuts and push them towards the designated piping end.
 - ▶ Depending on the type of piping end, connection parts are cemented, screwed or welded.
 - ▶ Diaphragm valve is then positioned between the connecting parts
 - ▶ Manually tighten the union nuts
 - ▶ Only identical materials can be joined together
 - ▶ Pipe sections with solvent cement connections should be rinsed unpressurized with water after the drying time
 - ▶ Only identical materials can be joined together

8 Initial operation



Risk of injury by increased control pressure and / or cavitation!

Higher control pressure or mechanical aids or cavitation can lead to damages of the Diaphragm Valve.

- ▶ Use mentioned control pressure to actuate the diaphragm valve.
- ▶ Use valve only at optimal operation conditions.
- ▶ Check that all valves are in the required open or closed position during the implementation.
- ▶ Fill the piping system in accordance to the technical data of all installed and related components and de-aerate completely.

8.1 Warning notices

NOTICE

Diaphragm Valve pressure testing has to follow the same regulations as the piping system!

- ▶ Before initial operation of the system perform a pressure test of the product.
- ▶ Make sure that the test pressure may not exceed the PN of the diaphragm valve. During the pressure test check the diaphragm valve and connections for leaks.

8.2 Adjustments for stroke limiter

As an option there are stroke limiters available for the function NC, NO and DA.

All valves equipped with a stroke limiter are delivered without any adjustments of the stroke limiter and correlate with the described function NC, NO or DA.

To adjust the stroke limiter use the following control pressure [bar]

Function NC: Control pressure max. 6 bar

Function NO: Control pressure max. 5 bar

Function DA: No control pressure during the adjustment process.

9 Maintenance



Risk of injury from escaping from the medium!

If the applied pressure has not been reduced completely media can escape uncontrolled while the piping systems is opened.

- ▶ Before removing / Maintenance / disassembly. Completely reduced pressure in the pipeline.
- ▶ In case of hazardous, flammable or explosive media: before removing the pipe, empty and rinse completely with the correspondent fluid. Observe possible residues.
- ▶ Take the necessary measures to ensure a safe collection of the medium
- ▶ If usage of diaphragm valve for dead-end: Do not open Diaphragm Valve while line is pressurized.



Risk of injury and missing product quality through use of spare parts which have not been provided by KOSCN Industry!

Risk of injury and damage possible.

- ▶ Only use the listed spare parts, see Chapter 11 “Spare parts list”.

For questions regarding the maintenance of the product, please contact your national KOSCN Industry representative.

9.1 Maintenance schedule

- ▶ Set maintenance intervals as per conditions of use (cycle times, media, environment, temperature or similar).
- ▶ As part of the regular intervals, carry out the following maintenance activities:

Maintenance interval	Maintenance activity
regular	▶ Check connection between the bonnet and valve body for tightness.
1-2 times per year	Check the functionality of diaphragm valves which are kept permanently opened or closed.
100,000 cycles with less than 6 bar nominal pressure at 20 °C and water	<ul style="list-style-type: none"> ▶ Visual inspection of the actuator. ▶ Disassemble the actuator and check the diaphragm for damage. ▶ If necessary, change diaphragm and O-ring.

 If the flow medium has higher temperatures, other chemicals or abrasive particles, we recommend more frequent inspections.

9.2 Replacing diaphragm



Risk of injury due to uncontrolled evasion of the medium!

If the pressure was not relieved completely, the medium can evade uncontrolled. Depending on the type of medium, risk of injury may exist.

- ▶ Completely relieve pressure in the pipes prior to dismounting.
- ▶ Completely empty and rinse pipe prior to dismounting in connection with harmful, flammable, or explosive media. Pay attention to potential residues.
- ▶ Provide for safe collection of the medium by implementing appropriate actions.

10 Troubleshooting list

Problem	Possible cause of fault	Problem fixing
Deformation and expansion of piping / valve	Pipeline forces are too high	▶ Improve support for the pipeline.
Premature wear of the diaphragm valve or individual parts	Material is not resistant	▶ Select appropriate materials, see Planning Fundamentals.
Leakage to the outside of the union nut	Loose connection of nut and valve body	▶ Tighten connection finger-tight.
	Damage seal	▶ Damage seal
Leakage between valve body and the cover connection	Housing not tightened properly	▶ Replace Diaphragm
Leakage at seat	Wear of diaphragms Fastening bolt	▶ Replace Diaphragm
Sluggish valve	Wear of sealing and / or spindle	▶ If necessary replace seals and other functional parts
Leakage of control medium on the non connected air connections	Wear of sealings	▶ Replace sealings on the spindle and piston.
Valves does not perform with specified	Control pressure is not selected correctly	▶ Check control pressure
Valve does not perform specified stroke or even does not open or close	Control pressure is not selected correctly	▶ Check control pressure
	Functions and connections for control medium are not compatible	▶ Check connection and suitable mode of function (NC,NO,DA)
	Defective aeration and deaeration line	▶ Check function of aeration and deaeration line

Leakage of medium at the indicator pin	Wear of Diaphragms and / or sealing	▶ Replace Diaphragm valve
Leakage of medium at the vent	Wear diaphragms and / or sealing	▶ Replace Diaphragm valve
Premature wear of Diaphragm	Incorrect control pressure	▶ Check control pressure
	Function and connection for control medium are not compatible	▶ Check connection and suitable mode of function (NC,NO,DA)
	Dirt in ventilation hole	▶ Check and clean if necessary deaeration drill on the intermediate part

11 List of spare parts

If no spare part code is specified, order as follows:

- ▶ Read code number and serial number of the diaphragm valve on the type.
- ▶ Position numbers and descriptions can be read out from the spare parts list.
- ▶ Send your order with these information to your representative of KOSCN industry.

12 Disposal

- ▶ Before disposing of the product separate the different materials, by recyclables, normal waste and special waste.
- ▶ Comply with local legal regulations and provisions when recycling or disposing of the product, the individual components and the packaging.
- ▶ Comply with national regulations, standards and directives.



Parts of the product may be contaminated with media that are harmful to health and the environment, so it is not enough just to clean them!

These media represent a risk of physical injury or damage to the environment.

Before disposing of the product:

- ▶ Collect any spilled media and dispose of according to the local regulations. Refer to the safety data sheet.
- ▶ Neutralise any media residues remaining in the product.
- ▶ Separate the materials (plastics, metals etc.) and dispose of them according to local regulations.



A product marked with this symbol must be taken to a separate collection point for electrical and electronic devices.